

BD FACSAria™ III Cell Sorter

Innovation is built in



Innovation is built into the BD FACSAria III

The BD FACSAria™ III cell sorter is built on the solid foundation of patented technologies, multicolor performance, and ease-of-use that has led to the success of the BD FACSAria™ cell sorter.

Since the introduction of the first BD FACSAria in 2003, each successive generation has opened the complex world of cell sorting to a broader audience of researchers and wider range of applications. Now, the BD FACSAria III system is even more powerful, dependable, and easy to use.

Here are a few of the new innovations that the BD FACSAria III has to offer:

Superior multicolor performance

To achieve superior multicolor performance, the fluidics and optical systems are precisely integrated to maximize signal detection.

Innovations include the laser excitation optics, the patented flow cell with gel-coupled cuvette, and the highly efficient patented octagon and trigon detection system. These systems work in unison, allowing the BD FACSAria III to achieve unrivaled sensitivity and resolution.

Expandable for the future, affordable today

The BD FACSAria III has flexibility built in. It can mount up to six lasers, so you can choose the configuration that meets your application investment and site requirements today—all the while knowing the system is expandable to up to six lasers to meet future needs.

An innovative new X-mount optical plate accommodates easy expansion to six lasers and four spatially separated beam spots. Wavelength choices now include 561-nm and 445-nm lasers, as well as the 488-nm, 633-nm, 405-nm, and 375-nm lasers. Mount up to 20 detectors, and measure a maximum of 18 colors simultaneously.

Smart, long-term investment

Unlike other instruments, the BD FACSAria enables customers to upgrade their existing instruments to the next generation platform instead of purchasing new systems.

The field upgrade is another unique BD innovation that can bring your BD FACSAria or BD FACSAria II system up to the capabilities of the BD FACSAria III. This capability makes the BD FACSAria platform the best possible choice and a smart, long-term investment.

Innovation has always been built into the BD FACSAria.

The new BD FACSAria III represents the latest innovations, offering advances that deliver reproducible results and superior performance.

BD FACSAria III—built to support your next great discovery.

Proven dependability and ease-of-use put the system in a class of its own

Sensitivity for multicolor and sorting applications

The fluidics system in the BD FACSAria III cell sorter is pressure driven. Positive air pressure forces sample cells through an optically gel-coupled cuvette flow cell. Hydrodynamic focusing guides particles in a single-file stream through the cuvette, where laser light intercepts the stream at the sample interrogation point.

Gel-coupled cuvette flow cell

At the heart of the BD FACSAria III is a quartz cuvette flow cell in true fixed alignment with the laser and gel coupled to the collection optics. For greater sensitivity, the BD FACSAria III incorporates a next-generation cuvette in the flow cell. Its patented design helps ensure that lasers are precisely focused on the sample stream, that they generate the greatest signal, and that the maximum amount of emitted light is collected.

Fixed alignment minimizes startup time, improves experiment-to-experiment reproducibility, and enables automated daily quality control. Most importantly, it also improves collection efficiency and optimizes resolution needed for multicolor applications, even at high-speed sorting settings.

In addition to other benefits, the next generation flow cell in the BD FACSAria III is designed to improve resolution for side population applications and DNA cell cycle analyses.

High-performance analysis, high-performance sorting

The desired sensitivity of the BD FACSAria III cell sorter is accomplished by using a similar gel-coupled flow cell design and the fixed optical architecture of the BD FACSCanto™ II and BD LSRFortessa™ systems.

This design architecture achieves high numerical aperture light collection. The flow cell and nozzle design enable low particle speeds in the analysis zone for maximum light collection, and then accelerate the particle through the nozzle at stream speeds to achieve the drop rates required for high-performance sorting.

Through the precise coordination of the optical and fluidics systems, the BD FACSAria III delivers exceptional optical detection sensitivity compared to traditional stream-in-air systems, in which particle speeds are the same for both analysis and sorting.

Four beam spots in the BD FACSAria III

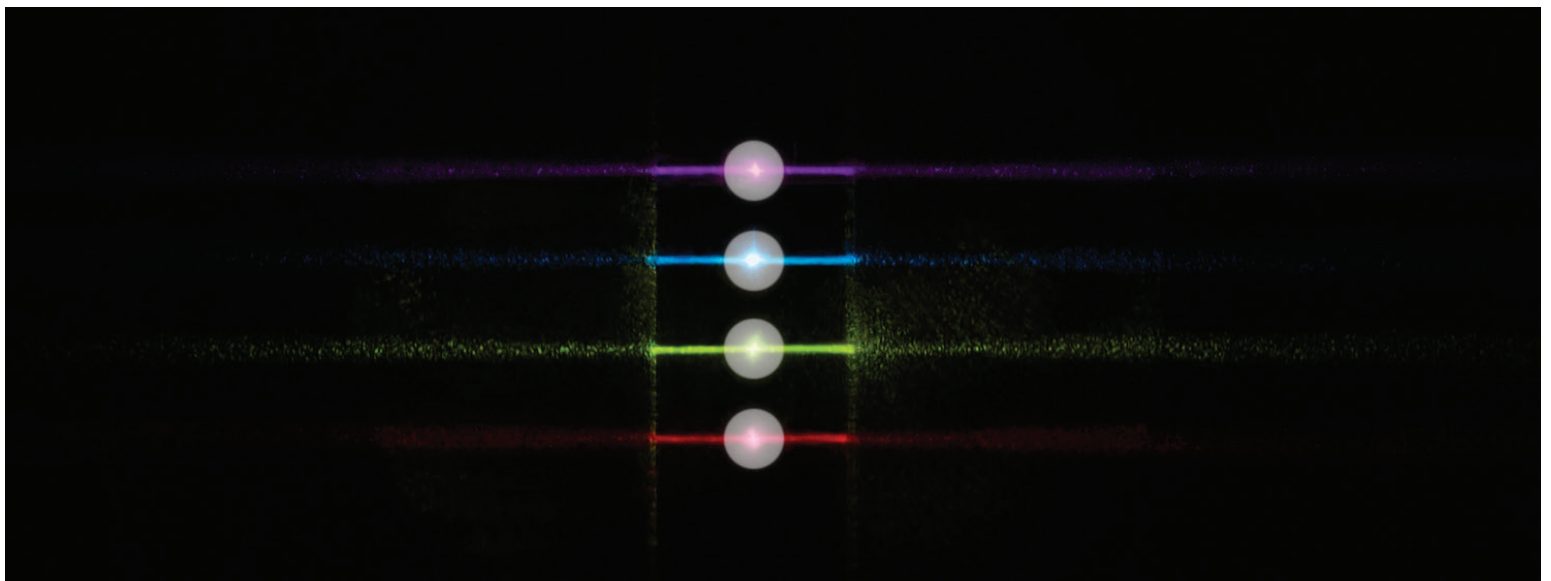

Nozzles for a range of particles

A choice of nozzles lets users sort a wide range of particle sizes. Nozzles are available in four sizes: 70, 85, 100, and 130 microns. Nozzles are readily accessible and easy to change, with a design offering tight registration for a secure fit. This means a reproducible drop profile after every nozzle exchange, resulting in reproducible instrument setup and alignment. The software sort setup matches pressure and sort settings to the nozzle being used.

Easy aseptic setup and cleaning

Innovations in the fluidics system such as easy-to-insert nozzles, automated sort setup, and easy-to-change filters make setup fast and simple. The fluidics design features integrated valve manifolds and a streamlined fluidics path. Software wizards make aseptic sort setup easy and effective. In addition, after a sample tube is run, both the inside and outside of the sample injection tubing are flushed to minimize carryover.

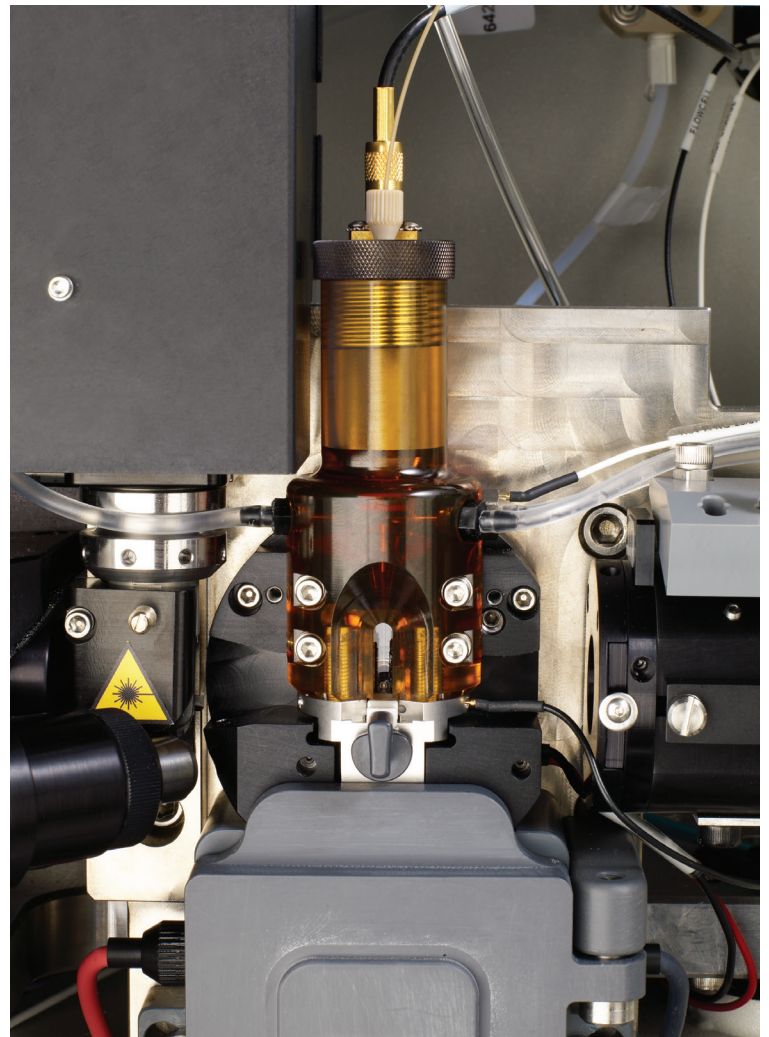

Cuvette flow cell and nozzle

BD FACS™ Accudrop technology simplifies drop delay determination

Patented BD FACS™ Accudrop technology assists the user to see the best drop delay value which is invisible to the naked eye. Software automation simplifies drop delay determination. Once the drop delay is calculated, the system automatically adjusts to maintain a constant break-off, called the Sweet Spot. Automatic clog detection stops the sort and protects the collection tubes if a clog is detected.

After passing through the cuvette, the stream accelerates through the nozzle and droplets are formed for sorting. Since particle interrogation occurs above the nozzle, insertion and removal of the nozzle can occur without realigning the optics or the fluid stream.

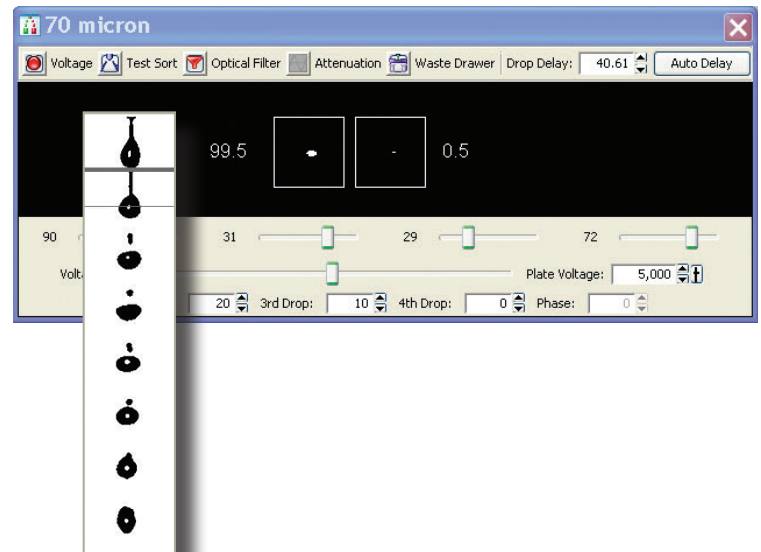

Fluidic system improvements are built in to make the system easier and safer to operate

Engineered into the system

Fluidics cart

A self-contained fluidics cart supplies sheath and cleaning fluids and collects waste from the cytometer. The cart also provides the air pressure and vacuum needed to achieve pressure from 5 to 75 psi, to accommodate a variety of cell sorting applications. BD FACSDiva™ software adjusts the air pressure. The fluidics cart is typically positioned directly under or to the left of the cytometer.

The fluidics cart holds a 10-L stainless steel sheath tank, a 5-L stainless steel tank used for shutting down the instrument with ethanol, and 10-L waste container. The sheath tank can be autoclaved. In addition, the cart holds three 5-L auxiliary cleaning fluid containers used in conjunction with the automated Prepare for Aseptic Sort mode.



Fluidics cart

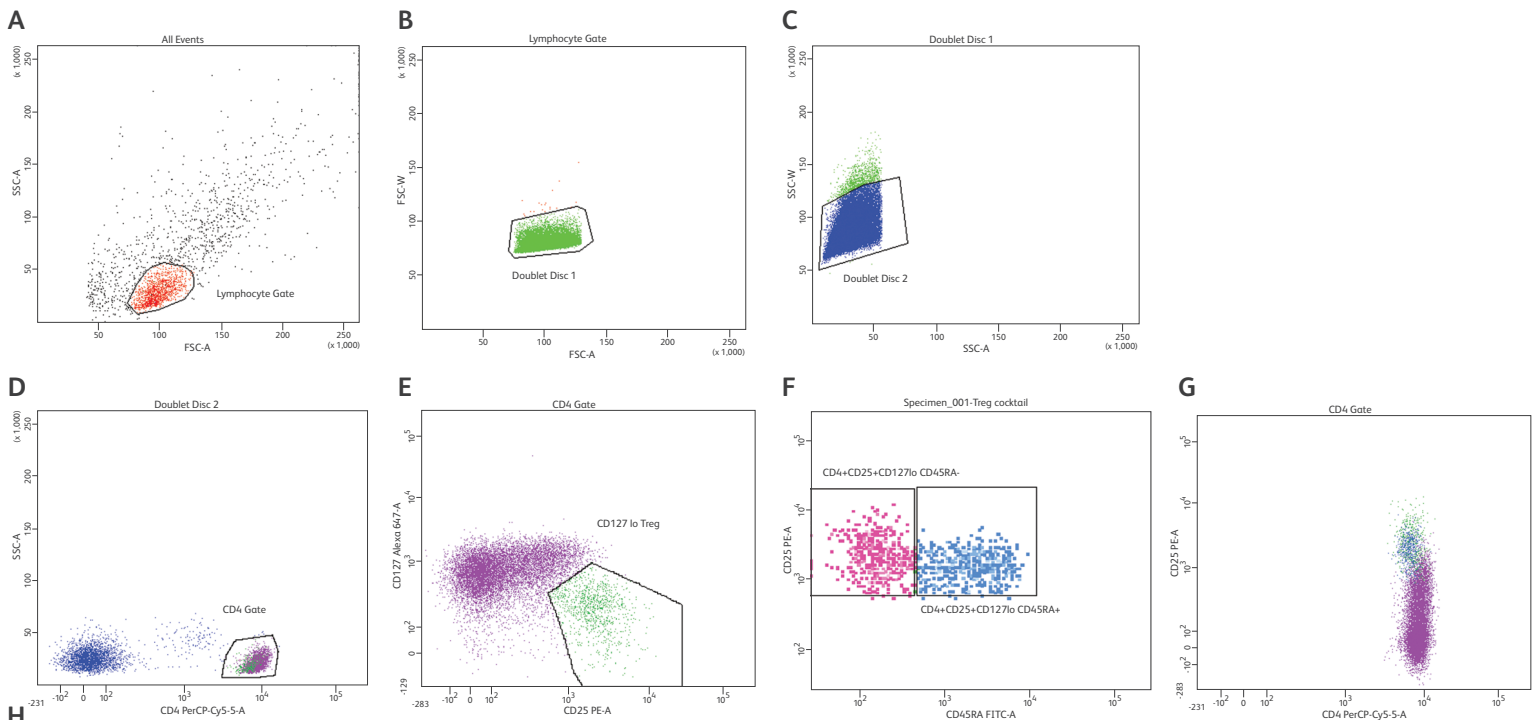

Tube: Treg cocktail

Population	#Events	%Parent	%Total
All Events	30,000	####	100.0
Lymphocyte Gate	22,506	75.0	75.0
Doublet Disc 1	22,394	99.5	74.6
Doublet Disc 2	22,302	99.6	74.3
CD4 Gate	11,137	49.9	37.1
CD127 lo Treg	944	8.5	3.1
CD4+CD25+CD127lo CD45RA	422	44.7	1.4
CD4+CD25+CD127lo CD45RA	515	54.6	1.7

Gating strategy used to sort CD45RA+ and CD45RA- Tregs

The BD FACSAria II system was set up for a sort using either a 70-µm or 100-µm nozzle (70 psi or 35 psi with a frequency of 87 or 60 kHz respectively). CD45RA+ Tregs and CD45RA- Tregs were sorted in purity mode at a rate of 10,000 to 11,000 events per second.

Sample injection chamber

During acquisition, the sample injection chamber is pressurized, forcing the sample to the cuvette flow cell. To simplify acquisition, the chamber temperature and agitation settings are controlled using BD FACSDiva software. A variety of tube holders are provided, from 15-mL centrifuge tube to 1.0-mL microtube size. To minimize clogging, 35- and 50-micron sample line filters are available.

From the sort block to the collection chamber

After leaving the nozzle, particles pass through the sort block that houses the deflection plates. The novel design fixes the plates in position for more efficient and reproducible deflection into a collection device in the sort collection chamber.

The sort block also houses an aspirator drawer that keeps the sort collection tubes covered until sorting begins and automatically closes to protect the tubes when the Sweet Spot is on and a clog is detected.

The sort collection chamber's universal mount design makes inserting the tube holders easier. The holders are designed to help maintain aseptic conditions when removing sort tubes. Temperature control for sort collection tubes, slides, and plates is available as an option.

Aerosol management

Engineered with aerosol management in mind, the BD FACSAria III features an enclosed pathway from the sample injection chamber to the sort collection tubes. For an added level of aerosol management, the BD® Aerosol Management Option (AMO) evacuates the sort collection chamber and traps aerosolized particles during sorting.

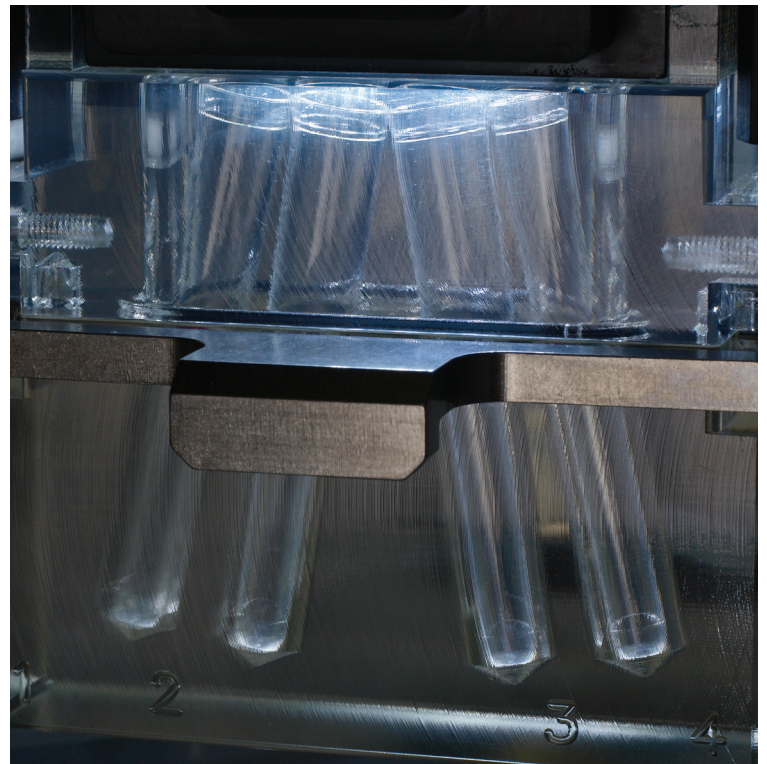

Sort collection chamber

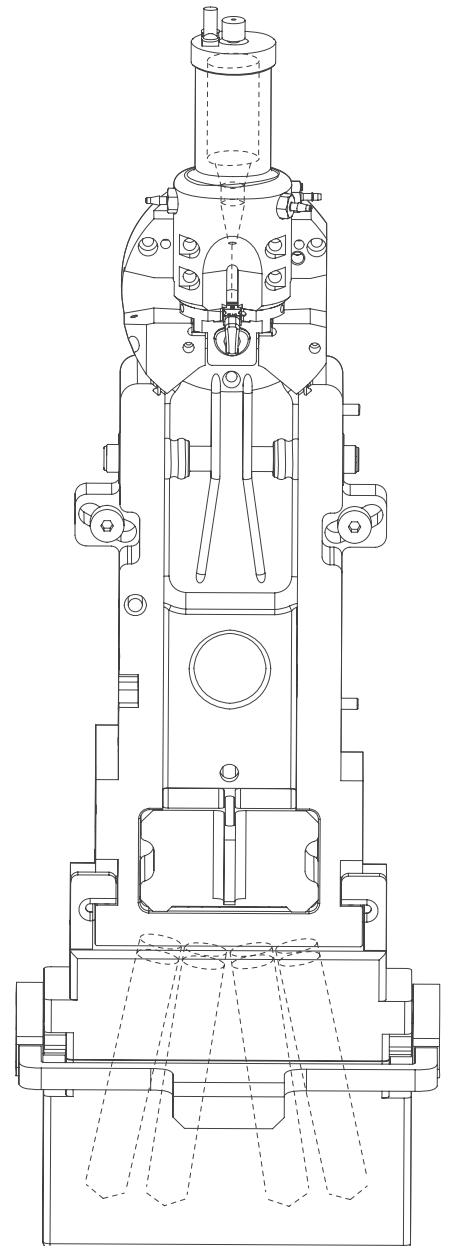

Sensitivity and resolution for deeper insights

Increased efficiency for multicolor detection

Innovations in the optical system, pioneered by BD, efficiently maximize signal detection and greatly increase sensitivity and resolution for each color in a multicolor assay. Enhanced sensitivity and resolution mean that even dim populations can be readily identified and sorted.

The optics system allows optimizing multicolor assays and panel design for superior results. The design allows choice of laser excitation wavelength(s) that illuminate cells in the sample, and collection optics that direct light scatter and fluorescence signals through spectral filters to detectors. Innovative designs for both the excitation and collection optics reduce excitation losses and dramatically improve collection efficiency, yielding better information from each sample.

Excitation optics

The excitation optics consist of multiple fiber launched fixed-wavelength lasers, beam shaping optics, and achromatic focusing lenses that produce beam spots that are spatially separated and concentrated ($9 \mu\text{m} \times 65 \mu\text{m}$). The more concentrated the beam spot, the higher the signal produced as each fluorescent labeled particle passes through the laser spot. Laser light is focused into the gel-coupled cuvette flow cell. Optical gel coupling to the fluorescence objective lens transmits the greatest amount of emitted light from the interrogation point to the collection optics. Since the optical pathway and the sample core stream are fixed, alignment is constant from day to day and from experiment to experiment.

Fixed alignment also ensures that there is no variability in experiment results introduced by manual optical adjustments.

Collection optics

Fiber optics deliver emitted light from the gel-coupled cuvette to the detector arrays. The collection optics are set up in patented octagon- and trigon-shaped pathways that maximize signal detection from each laser illuminated beam spot. This is accomplished by transmitting the highest wavelengths (which have the fewest photons of light) to the first photomultiplier tube (PMT), and reflecting lower wavelengths to the next PMT through a series of longpass dichroic mirrors.

This design is based on the principle that light reflection is more efficient than light transmission. Emitted light travels to each PMT via reflection and is transmitted through only two pieces of glass to reach each detector. Therefore, colors can be detected with minimum light loss.

Bandpass filters in front of each PMT allow spectral selection of the collected wavelengths. Importantly, this arrangement simplifies filter and mirror changes within the optical array and requires no further alignment for maximum signal strength.

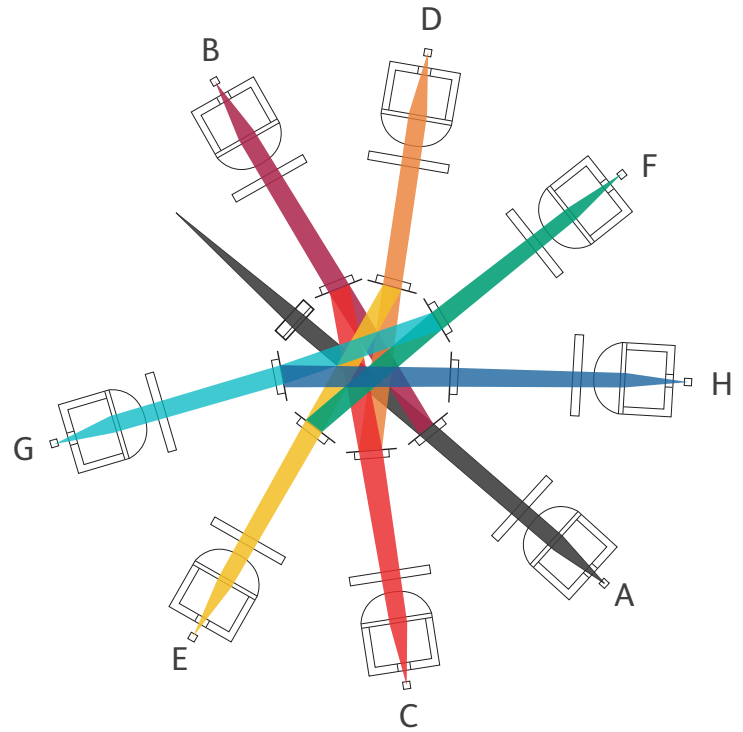

Transmission pathways in an octagon

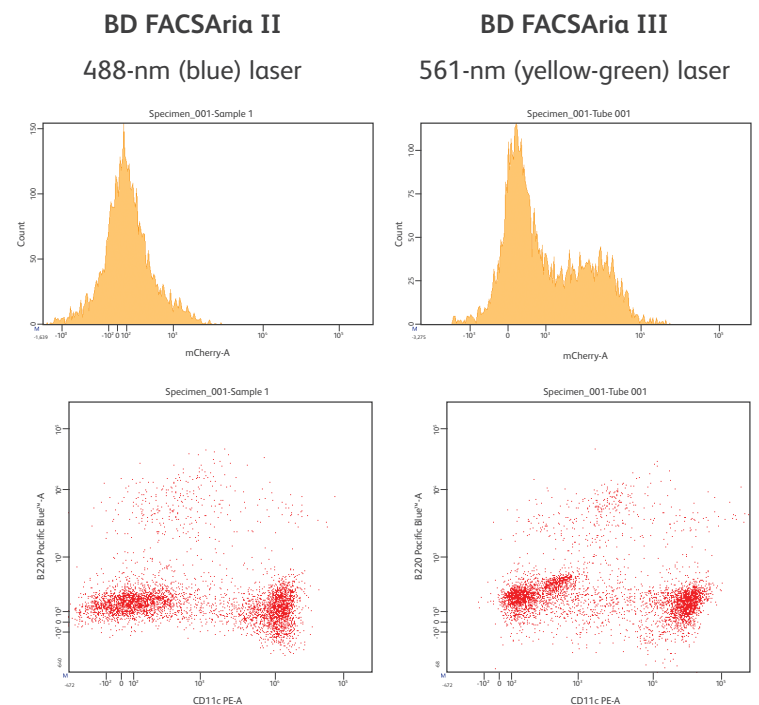

The 561-nm laser excites mCherry and PE more efficiently compared to the 488-nm laser.

The same sample of stained mouse spleen cells was acquired using a BD FACSAria II (488-nm, 405-nm, and 633-nm lasers) and BD FACSAria III (488-nm, 405-nm, 633-nm, and 561-nm lasers). Dim staining populations can only be detected using the 561-nm laser.

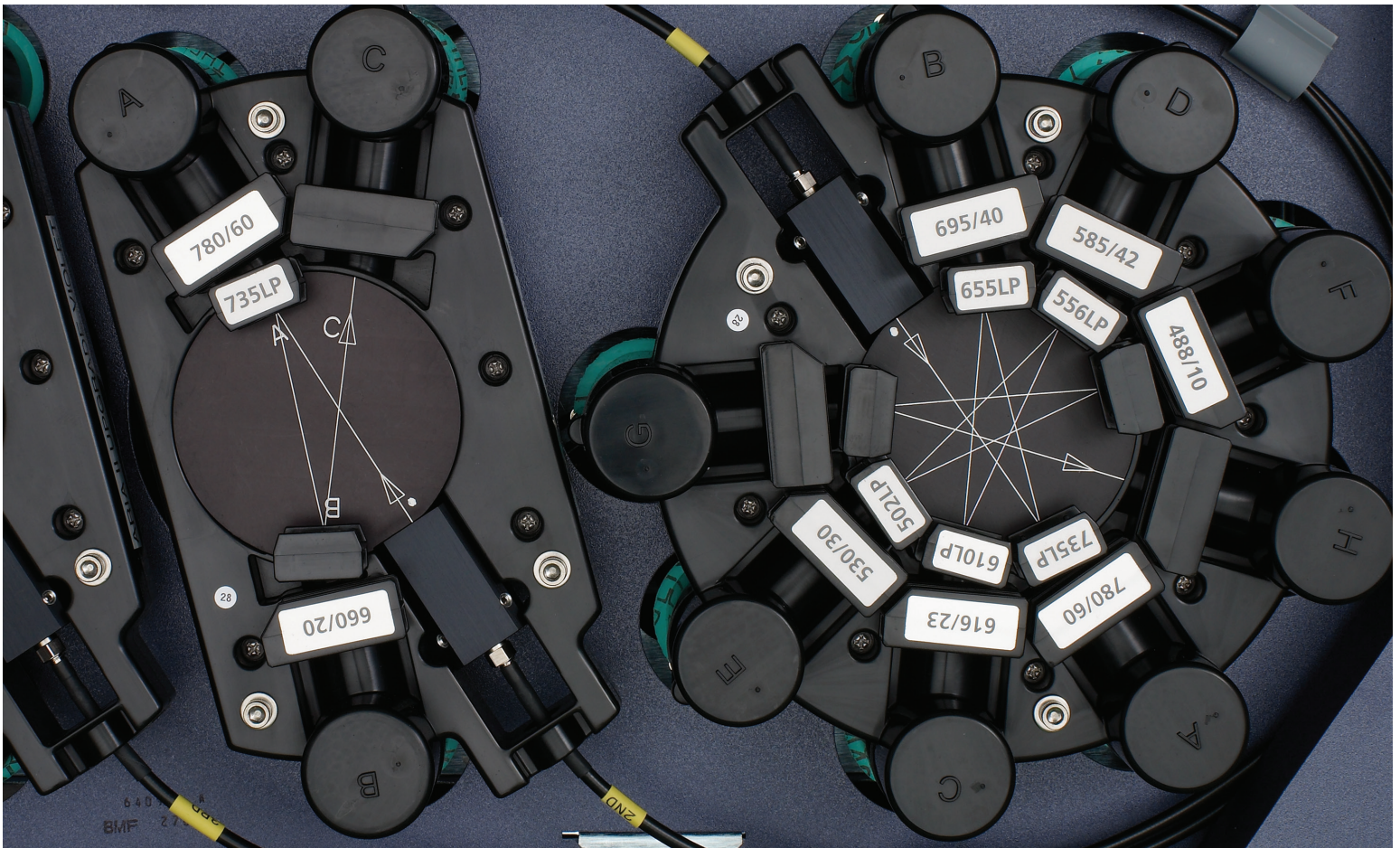

Tricon and octagon detector arrays

Precision optical design

The many innovations in the BD FACSAria III's optical system, such as the patented gel-coupled cuvette and octagon detection system, and the $9\ \mu\text{m} \times 65\text{-}\mu\text{m}$ beam spot, are designed to work

together to maximize sensitivity and resolution. This precision design delivers a more efficient optical system enabling the use of lower powered lasers, which in turn reduces the total cost of instrument operation.

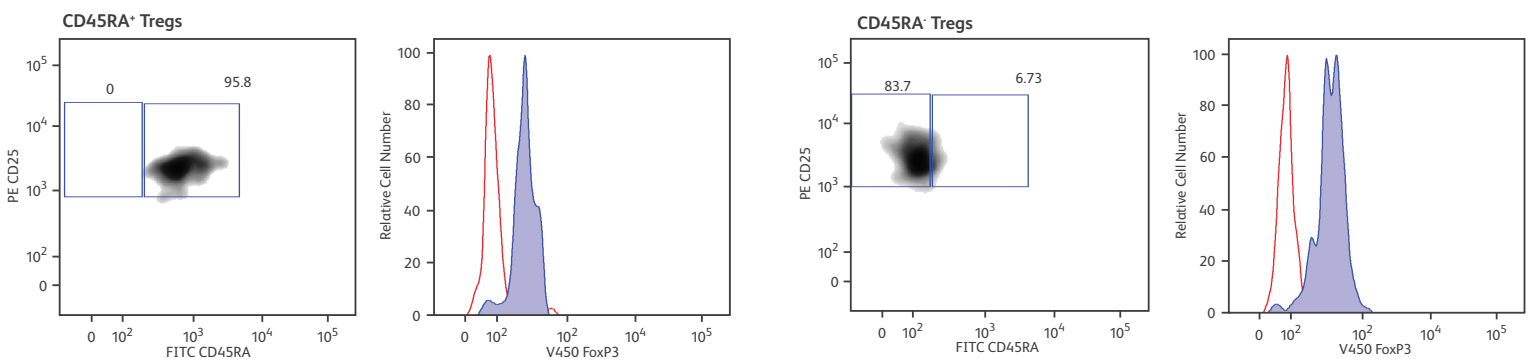

Representative FoxP3 staining of sorted Tregs

To determine purity, as defined by FoxP3⁺ status, a portion of the cells was stained with anti-human FoxP3 BD Horizon™ V450. Data is representative of 10 experiments.

Keep up with future needs with a simple upgrade

Multicolor flexibility

Flexible for present and future needs

For many users, the capability of an advanced cell sorter is defined by its flexibility, which in turn is defined by the number of parameters that can be detected simultaneously. With flexibility built in, the BD FACSAria III can support six lasers and four spatially separated beam spots. Choose up to six laser wavelengths—633 nm, 561 nm, 488 nm, 445 nm, 405 nm, and 375 nm—and up to 20 detector positions, to measure up to 18 colors simultaneously.

Upgradeable and backward compatible

Users can design a configuration that meets their lab's budget and site requirements today and have a growth path for the future. They can expand the BD FACSAria III system with additional lasers via a field upgrade. In addition, customers with BD FACSAria or BD FACSAria II systems can upgrade them to the new capabilities of the BD FACSAria III with a field upgrade.

Lower cost of ownership

The unique, efficient design of the optical system delivers a lower cost of operation than stream-in-air sorters. The BD FACSAria III delivers maximum sensitivity and resolution using fiber launched solid state lasers. No special power or cooling is needed for these lower powered air cooled lasers.

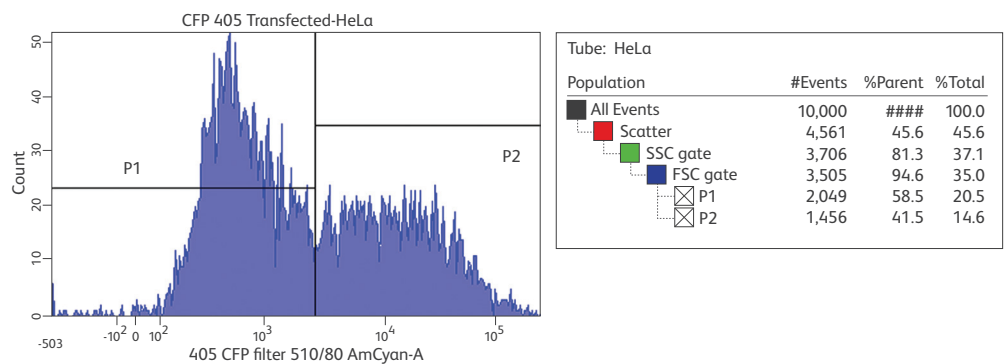
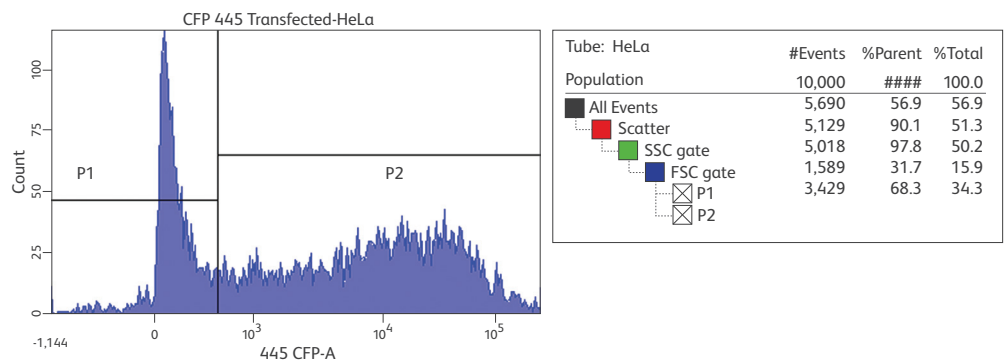

CFP-transfected HeLa cells

The 445-nm laser excites Cyan Fluorescent Protein (CFP) more efficiently compared to the 405-nm laser. The same sample of CFP-transfected HeLa cells was acquired on the BD FACSAria III and excited either by the 445-nm laser or by the 405-nm laser. The cells excited by the 445-nm laser demonstrated improved separation compared to those excited by the 405-nm laser.

Configure your BD FACSAria III

Up to 6 lasers • Up to 18 colors

Laser choices: 633, 561, 488, 445, 405, 375 nm

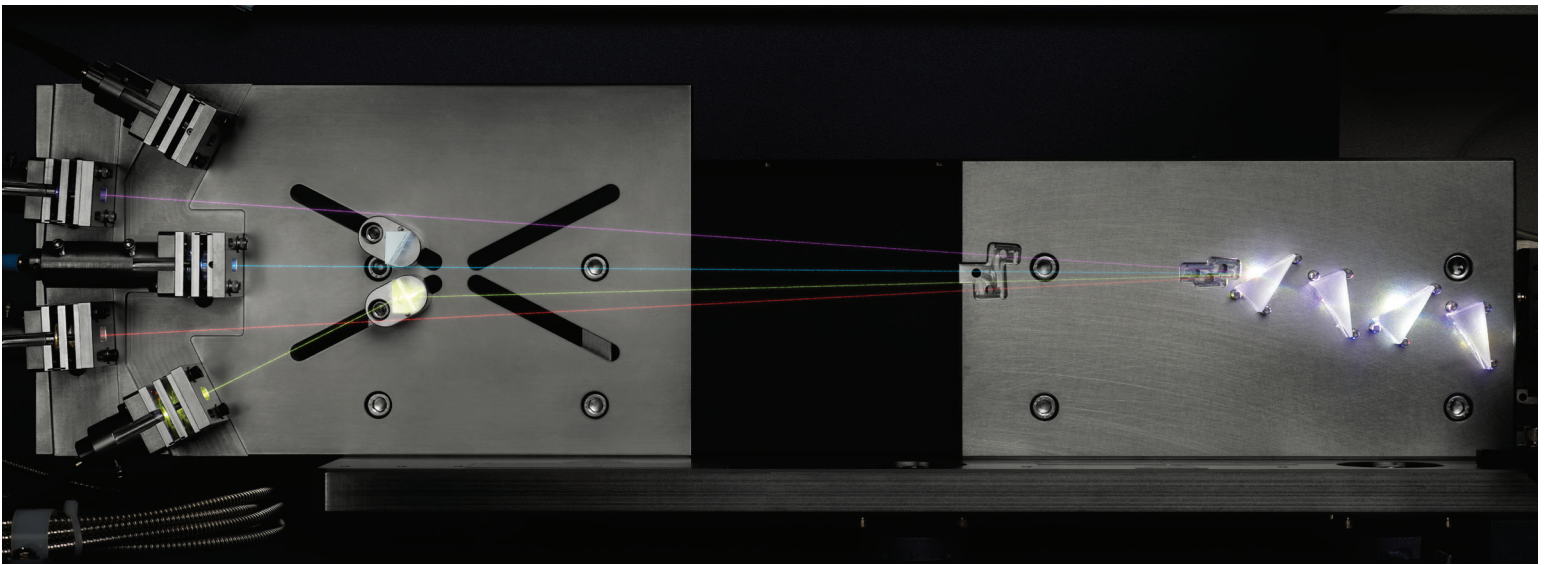

New X-mount Optical Plate

Mouse bone marrow side population

Mouse bone marrow cells were stained with Hoechst 33342, c-Kit, Sca-1, and lineage markers, and run on the BD FACS Aria III equipped with a 375-nm laser.

The SP fraction (red) was limited to those cells expressing c-Kit⁺ Sca-1⁺.

Antibodies used were c-Kit PE, Sca-1 PE-Cy7, Lineage FITC, CD34 APC, CD45 APC-Cy7, PI, Hoechst Blue, and Hoechst Red.

Tube: mouse BM CD34KSL Hoechst 5 *0ug/ml

Population	#Events	%Parent	%Total
All Events	1,000,000	###	100.0
Cells	859,338	85.9	85.9
PI-	808,841	94.1	80.9
Doublet	800,858	99.0	80.1
Doublet-	799,149	99.8	79.9
CD45+	790,724	98.9	79.1
Lineage-	144,071	18.2	14.4
c-Kit+ Sca-1 + Lin-	4,610	3.2	0.5
Side population	698	0.5	0.1
c-Kit+ Sca-1 + Lin- AND Side population	665	0.5	0.1

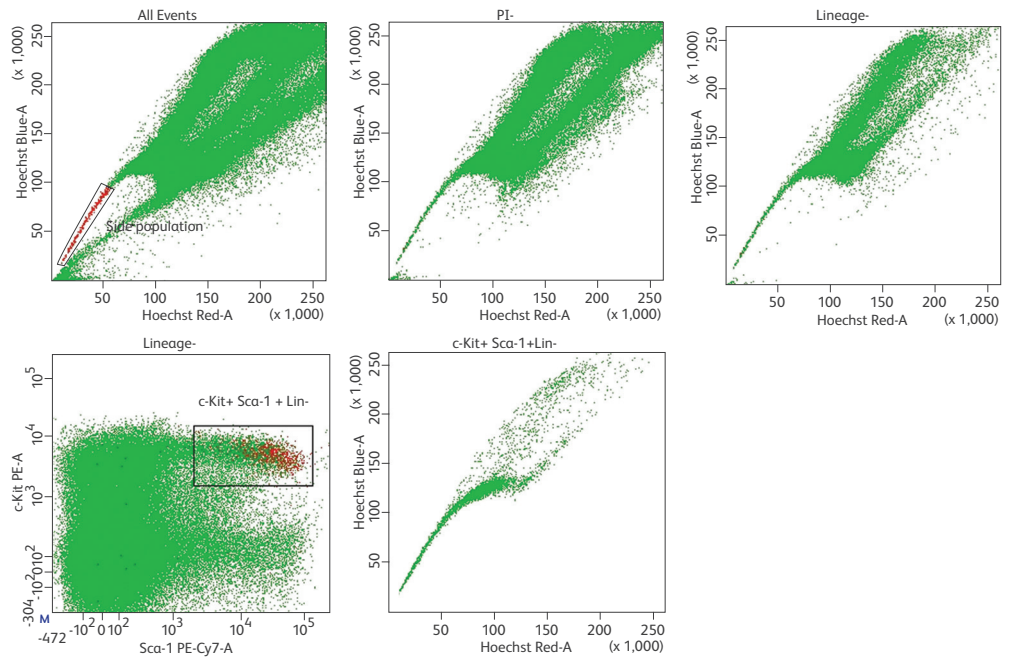

Cancer cell line side population

Human HT-29 colon cancer cells were stained with Hoechst 33342 and acquired on the BD FACS Aria III equipped with a 375-nm laser (left dot plot).

As a control, side population expression was blocked (right dot plot).

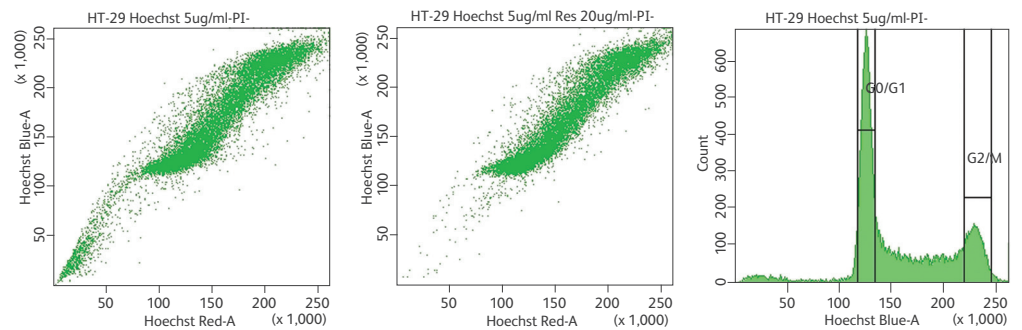

Tube: HT-29 Hoechst 5ug/ml

Population	#Events	%Parent	%Total
All Events	20,000	###	100.0
Cells	19,525	97.6	97.6
FSC Doublet-	19,264	98.7	96.3
SSC Doublet-	18,997	98.6	95.0
PI-	18,427	97.0	92.1
Side Population	650	3.5	3.2
G0/G1	7,395	40.1	37.0
G2/M	2,904	15.8	14.5

BD FACSDiva software helps you move from analysis to sorting

Compatible with other BD analyzers and sorters

BD FACSDiva software efficiently controls the setup, acquisition, and analysis of flow cytometry data from the BD FACSAria III workstation. BD FACSDiva software is common across many BD cell analyzers and cell sorters, including BD FACSCanto and BD[®] LSR systems. Researchers gain application flexibility because it is easier to move the assay design and optimization to another platform, for example, from analysis to sorting.

The Cytometer Setup and Tracking (CS&T) feature of BD FACSDiva software establishes baseline settings and optimizes instrument sensitivity and fluorescent resolution. The software reduces the chances of operator error, and ensures consistency of results. It allows for the creation of application-specific settings for rapid performance of routine experiments in a more consistent manner. Tracking capabilities in the software measure a number of instrument settings and report on performance, simplifying daily quality control. Levey-Jennings plots help users understand instrument performance and identify maintenance issues.

Acquisition and analysis

BD FACSDiva software enables researchers to preview and record data from multiple samples with an automated acquisition process. The software manages acquisition templates, experiment layouts, and compensation procedures to further facilitate data acquisition.

Fast startup to sort time

- 1 Turn on the sorter.
- 2 Start the fluidics.
- 3 Perform automated setup, QC, and drop delay optimization.
- 4 Optimize the sample.
- 5 Perform the sort.

Platform comparison using CD4

Comparison of whole blood stained with single-color CD4 FITC, CD4 APC, and CD4 Pacific Blue[™] and run on both the BD FACSAria II and BD FACSCanto II systems. The BD FACSAria II was set for high-speed sorting (70 psi and 90 kHz), and both instruments were set up using BD Cytometer Setup and Tracking software.

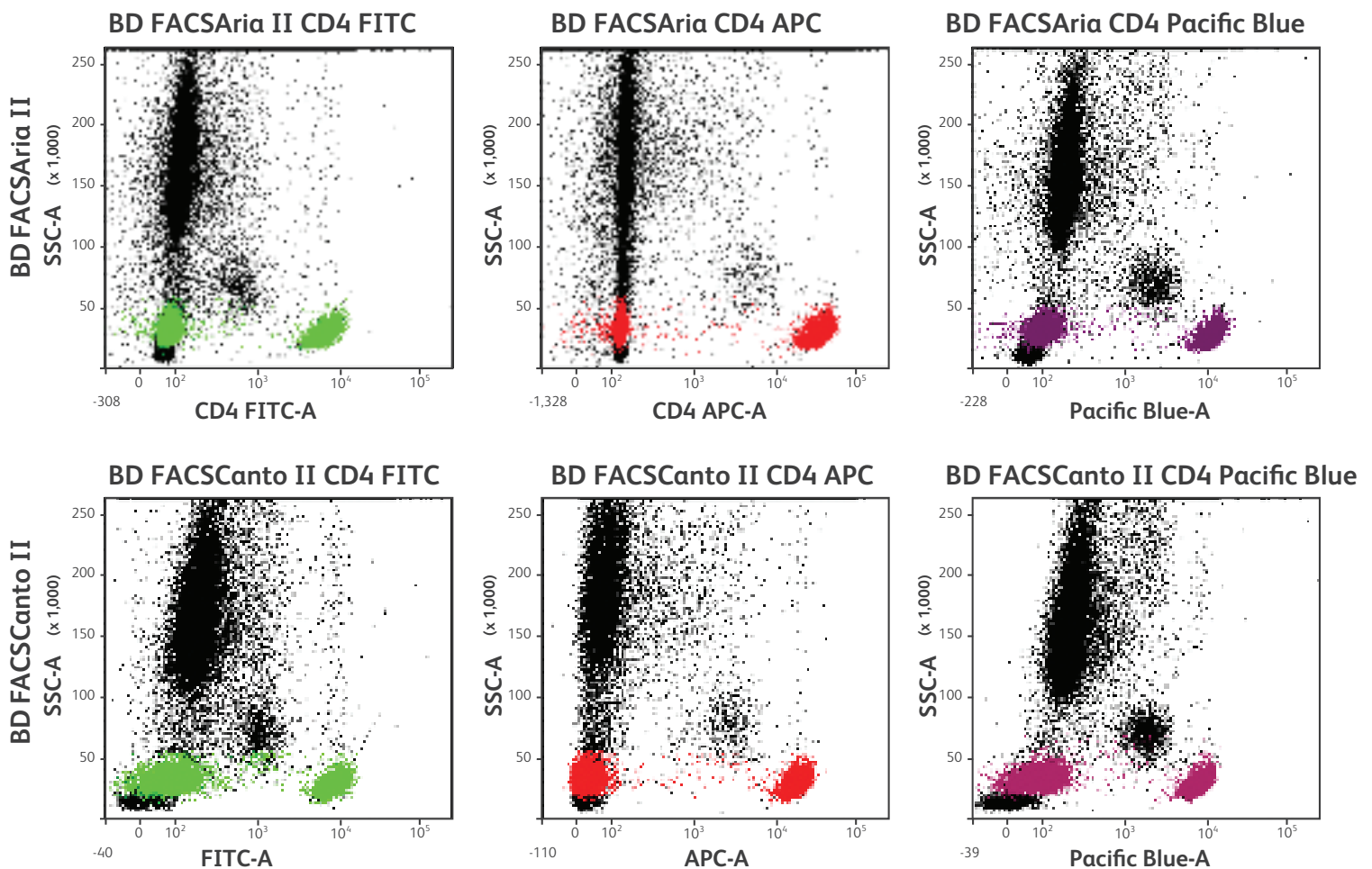

For efficient and convenient analysis, the software provides automated hierarchical snap-to gating, user selectable plot configurations, and batch analysis function. Recorded data can be analyzed by creating plots, gates, population hierarchies, and statistical views on a BD FACSDiva global worksheet. Once the global worksheet is saved, it can be used to analyze multiple sample tubes from an experiment, thereby saving time. Other productivity benefits come from features such as user-definable batch analysis and automated gate resizing, pausing between data files, exporting statistics, and printing before proceeding to the next data file.

Digital electronics

The gel-coupled cuvette and electronics operate together to deliver the maximum amount of signal information about each particle. The electronic sampling rate is precisely matched to the speed of the particles flowing through the cuvette. The BD FACSAria III electronic design has demonstrated linear and accurate event data acquisition at up to 70,000 events per second (shown in graph below).

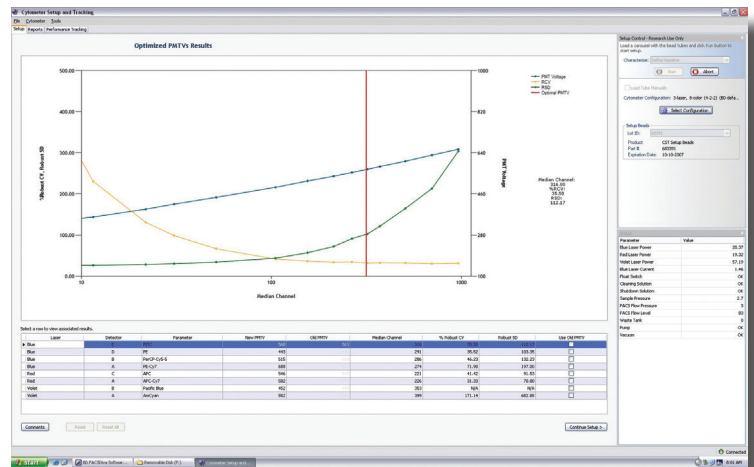
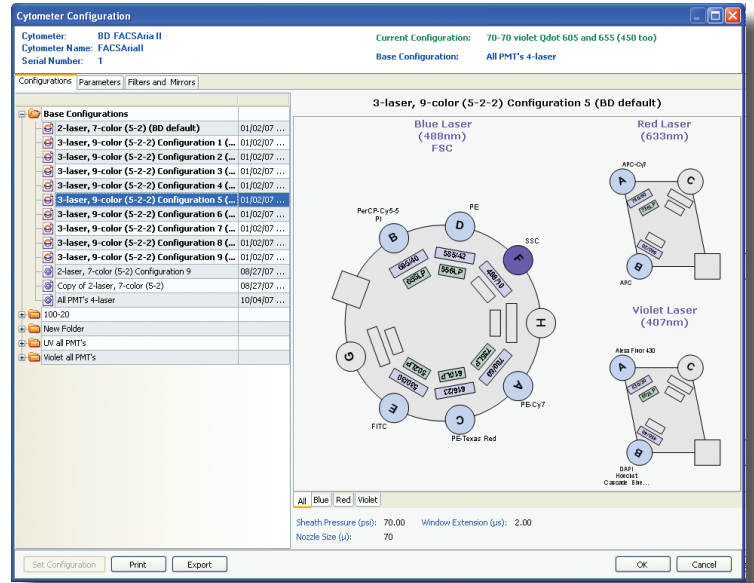

BD Cytometer Setup and Tracking software

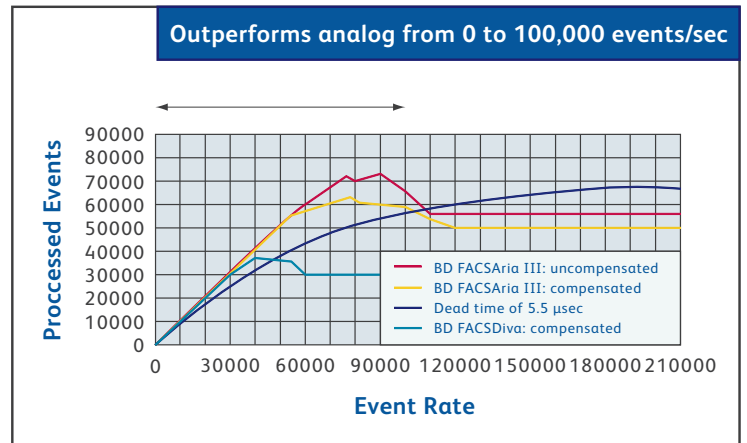

BD FACSAria III system acquisition rates

Services

BD Life Sciences is fully committed to the success and satisfaction of its customers. The BD FACSAria III cell sorter is backed by a world-class service and support organization with unmatched flow cytometry experience.

Since commercializing the first cell sorter in 1973, BD has been delivering flow cytometry systems that are even more powerful, dependable and easy to use. This expertise is made available to BD FACSAria III customers through comprehensive training, applications and technical support and expert field service.

Training

Hands-on training is included with each BD FACSAria III cell sorter. In addition, training courses are held at BD training centers worldwide. BD flow cytometry courses combine theory and practice to provide participants with the skills and experience they need to take full advantage of the capabilities of the BD FACSAria III cell sorter.

Technical application support

BD Life Sciences technical applications support specialists are available to provide field- or phone-based assistance and advice. Expert in a diverse array of topics, BD technical application specialists are well equipped to address customer needs in both instrument and applications support.

Field service

When instrument installation or service is required, a BD Life Sciences Technical Field Service Engineer can be dispatched to the customer site. BD Life Sciences field service engineers are located across the world. On-site service and maintenance agreements are available to provide long-term support for the BD FACSAria III.

Custom services

Mobilizing technology for research applications requires close collaboration. The Custom Technology Team (CTT) at BD Life Sciences works with customers to provide solutions through custom reagents, panels, or assay protocols.

Staffed by leading scientists with breadth and depth of technical expertise in cytometry, the CTT team will coordinate with researchers to study the problem at hand, make recommendations, and help implement the solutions. In this way, BD Life Sciences technical know-how is translated into practical solutions that allow customers to focus on research.

Special Order Research Products

Instruments can be customized to meet customer requirements via the Special Order Research Products (SORP) programs.

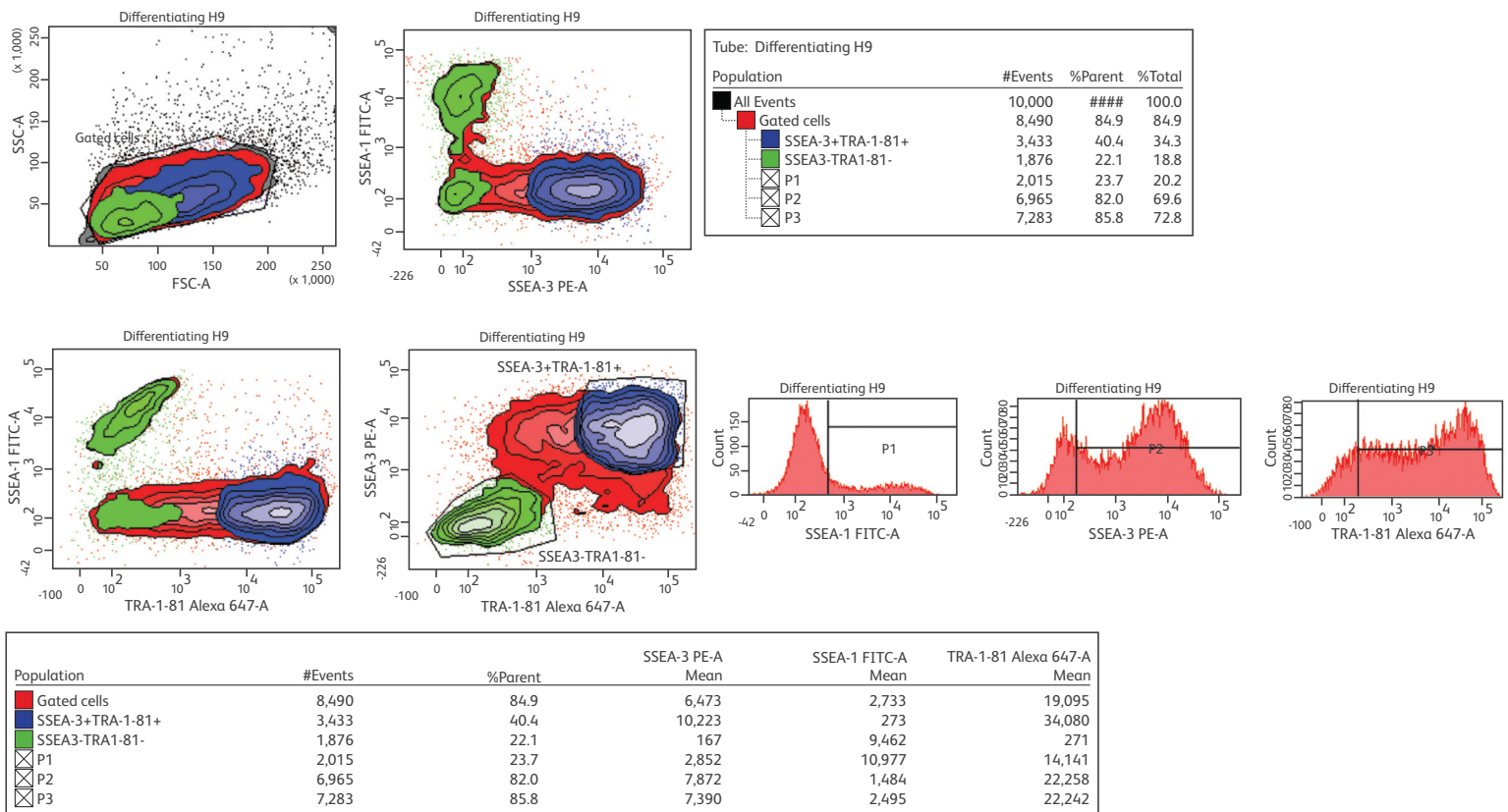

Differentiating H9 cells stained and run on the BD FACSAria II using the BD Stemflow™ Human Pluripotent Stem Cell Sorting and Analysis Kit.

This kit contains three different fluorescent antibodies that can be used to identify both undifferentiated (TRA-1-81 and SSEA-3) and differentiated (SSEA-1) pluripotent stem cells. This combination of markers has been widely used to characterize and isolate differentiated and undifferentiated stem cells derived from hESCs and iPS cells.

BD Life Sciences Regional Offices

bdbiosciences.com

Australia

Toll Free 1800.656.100
Tel 61.2.8875.7000
Fax 61.2.8875.7200

Canada

Tel 866.979.9408
Fax 888.229.9918

China

Tel 86.21.3210.4610
Fax 86.21.5292.5191

Europe

Tel 32.2.400.98.95
Fax 32.2.401.70.94

India

Tel 91.124.2383566
Fax 91.124.2383224/25/26

Japan

Nippon Becton Dickinson
Toll Free 0120.8555.90
Fax 81.24.593.3281

Latin America/Caribbean

Toll Free 0800.771.71.57
Tel 55.11.5185.9688

New Zealand

Toll Free 0800.572.468
Tel 64.9.574.2468
Fax 64.9.574.2469

Singapore

Tel 65.6690.8691
Fax 65.6860.1593

United States

US Orders 855.236.2772
Technical Service
877.232.8995
Fax 800.325.9637

Office locations are available on our websites.

Class 1 Laser Product.
For Research Use Only. Not for use in diagnostic or therapeutic procedures.

BD Life Sciences, Milpitas, CA 95035, U.S.

bdbiosciences.com



BD, the BD Logo, BD FACSDiva, BD LSRFortessa, FACS, FACSria, FACSCanto and Horizon are trademarks of Becton, Dickinson and Company or its affiliates. All other trademarks are the property of their respective owners. © 2023 BD. All rights reserved. Formerly 23-11539-01

Alexa Fluor and Pacific Blue are trademarks of Life Technologies Corporation. Cy is a trademark of Global Life Sciences Solutions Germany GmbH or an affiliated doing business as Cytiva.